

special teeth-profile and special joint-profile

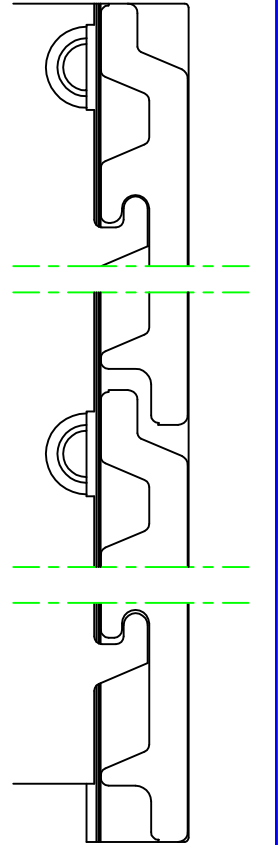

INDUSTRIAL RIGHTS APPLIED FOR
subject to amendments, Issued 2003-05

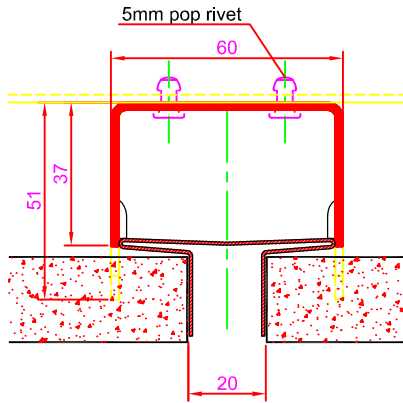
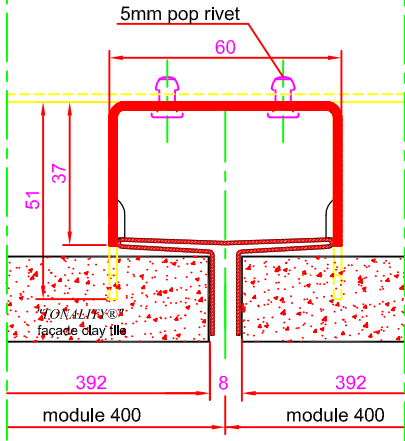
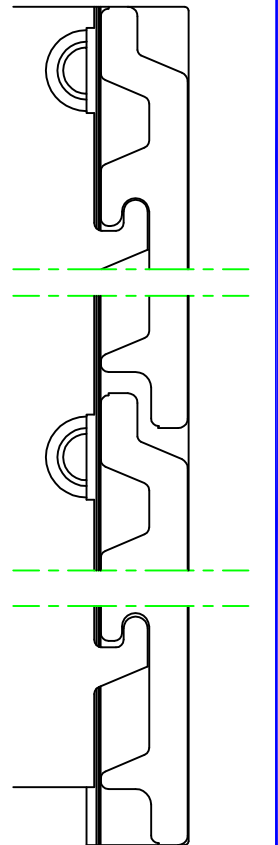
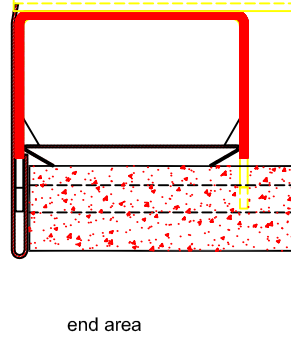
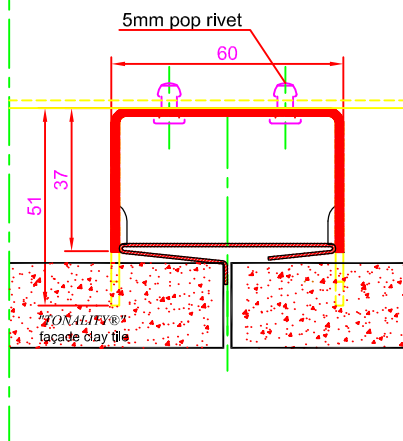
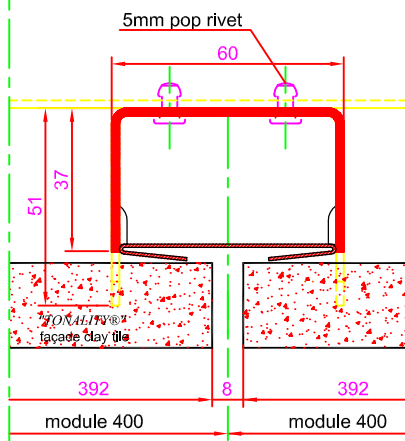
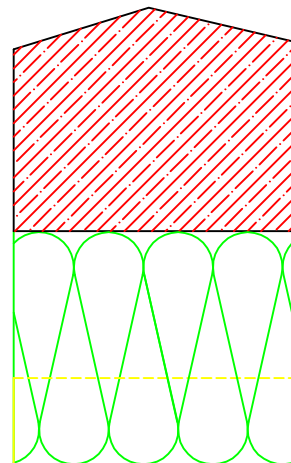
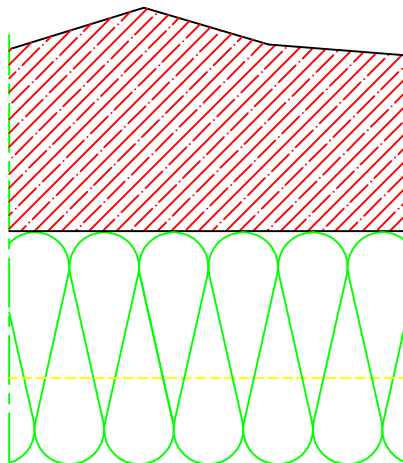
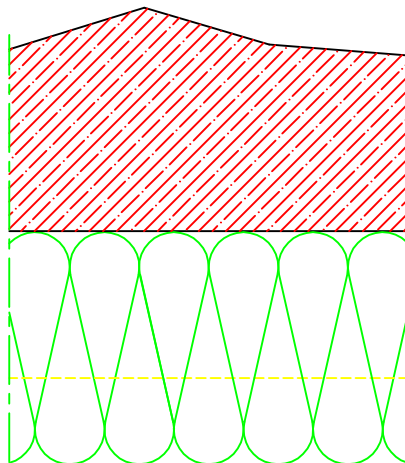

INDUSTRIAL RIGHTS APPLIED FOR
subject to amendments, issued 2003-05